

# Excel Specialist Support Services

[www.excel-networking.com/specialist-support-services](http://www.excel-networking.com/specialist-support-services)

Section 15



## In this Section:

[Pre-Terminated Solutions](#)

[Copper](#)

[Fibre](#)

[MTP](#)

[Bespoke Laser Engraved Labelling](#)

[Pre-Configured Racks and On-Site Rack Assembly](#)

## Pages

169

171

177

182

187

191

**NEW**  
for **V5**

## Introducing Excel's Specialist Support Services

At Excel Networking Solutions, we are dedicated to providing customers with high quality end-to-end infrastructure solutions. Designed with installers in mind, we offer a range of Specialist Support Services, which are ideal for projects with limited time available on-site for installation or for rapid deployment projects. Having a trusted partner that can deliver expertly inspected, fully traceable and 100% tested systems helps alleviate pressure. Our range of Specialist Support Services are carried out by our team of trained experts at our Birmingham HQ.

By providing installers with pre-tested, pre-qualified products, we are helping them to deploy products faster and to reduce their costs by removing the need to invest in specialist equipment, labour and management costs. The risk of any issues arising can be significantly reduced or even removed by utilising the range of support services available from Excel Networking Solutions.

### Our Specialist Support Services include:



#### Pre-Terminated Copper

Our pre-terminated copper solutions are available in all categories of copper cable in screened and unscreened constructions. Our team can supply cables as single or loomed assemblies, fitted with modules, jacks or plugs at either or both ends or pre-installed into a pre-labelled patch panel.

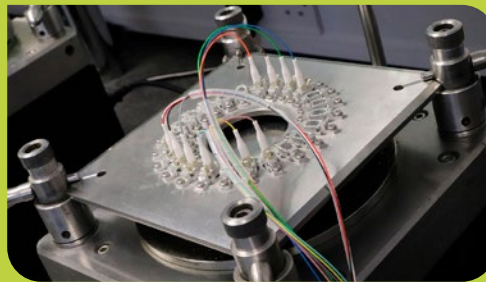

#### Pre-Terminated Fibre

Our team of experts provide a range of pre-terminated fibre solutions across singlemode and multimode fibre constructions, with bespoke break out lengths and terminated into cassettes or patch panels as required. Our team take additional steps to machine polish the fibre endfaces and use an interferometer to check ferrule geometry to ensure optimum performance in any environmental condition.



#### Pre-Configured Racks and On-Site Rack Assembly

We can either pre-configure Environ racks and deliver them to site ready-built, or we can arrange for our team of installation specialists to visit the site and build them in-situ. In addition to constructing the shell of the racks, we can also install PDUs, fan trays, cable management, shelving and unique locking solutions as part of this service.



#### Bespoke Laser Engraved Labelling

Our comprehensive range of labelling sheets ensure that every application is professionally labelled from the moment it is installed. As part of our 100% bespoke laser engraved labelling service, we can print labels for cabinets, patch panels, outlets, cables, GOPs and modules with any wording, specific IDs or logos required to suit your specification.



Reduce Cost



Save Time



Minimise Waste



Optimum Flexibility



Enhanced Reliability

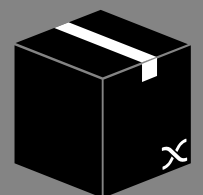

Fast Turnaround



## SPECIALIST SUPPORT SERVICES

EXCEL NETWORKING OFFERS A COMPREHENSIVE RANGE OF SPECIALIST SUPPORT SERVICES, COVERING COPPER AND FIBRE PRE-TERMINATED SOLUTIONS AND CABLE TESTING AS WELL AS LASER ENGRAVED LABELLING.



Watch Now on  
youtube

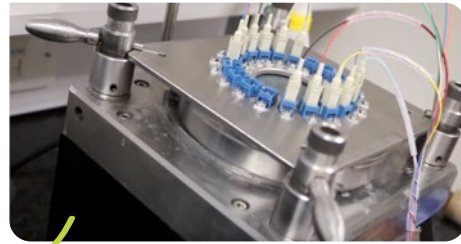

## Pre-Terminated Solutions

The conventional way to deliver a copper or fibre infrastructure cabling system has been for the cable, connecting hardware and accessories to be installed and terminated on site. The installation is typically programmed to fit in with all other project works. Projects may be subject to unforeseen delays, and as the infrastructure cabling packages are usually towards the end of the project, these may be under greater pressure to speed up to ensure the overall project is not delayed.

Pre-terminated solutions are ideal for projects with limited time available on-site for installation or for rapid deployment projects, such as a disaster recovery. They provide a fully traceable and warranted system and could reduce the installation time as much as 75%.

A range of benefits are available from our pre-terminated solutions, time saving and repeatable quality being two of the most obvious. But the Excel offering brings much more as the system is more flexible than any others, ultimately allowing the customer to retain control of cost and design.

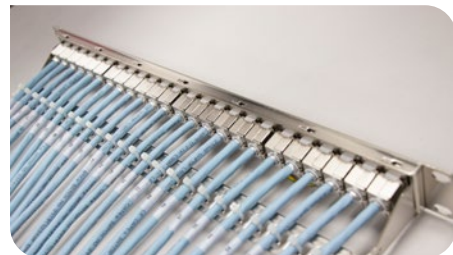

## Labelling

Each pre-terminated assembly has a unique serial number to enable full traceability and tracking through the manufacturing process. The serial number label is attached to each end of the cable assembly. The cables can be uniquely labelled according to any specific ID's required.

Laminated (Traffolyte type) labels can be engraved and attached to the shutters, modules, GOPs, panels etc as required. These are available in a wide range of colours and configurations.



S15

**MAYFLEX**  
A Sonepar Company

FLUKE NETWORKS

Discover more specialist support services available from Mayflex  
Including: Camera and Bracket Spraying, Pre-Staging Devices, Fluke Support and more

SPECIALIST SUPPORT SERVICES

### Manufacturing process

The pre-terminated assemblies are manufactured in the Excel facility under controlled conditions and to ISO9001 procedures, using the latest equipment, assuring the highest quality of product, matching the customer's specification and configuration.

Fibre optic assemblies are terminated using heat-cure epoxy, machine polished, 100% inspected and geometry checked using an interferometer.



### Testing

All Excel pre-terminated assemblies are 100% inspected and tested using the best equipment available. All equipment is fully maintained and calibrated annually. All test results are stored electronically, and test certificates are supplied with every assembly. The certificates can also be shared electronically if required.

Single-ended assemblies are usually made double-ended to allow for a full test, then cut in half.

Special testing can be provided, such as OTDR testing for fibre, with full traces provided. For copper, testing is carried out using Fluke DSX testers with full plot and graph data stored.

Each pre-terminated cable is given a unique reference number and is provided with a full test certificate, supplied in a choice of soft or hard copy. Test results can be saved using your preferred ID sequence.



Tender Specifications will typically require full testing of the system once it has been installed in its final position. This should be completed in line with the testing methodology contained within our Installation Guidelines in Section 12.

### Logistics

Excel is more than aware that successful projects rely on seamless logistics. Planning and delivery can make or break the project. Therefore, Excel can work with installers to schedule deliveries to meet the programme, ensuring the smooth running of the installation, by eliminating onsite storage which adds handling time and takes up valuable space. All pre-terminated drums, boxes and pallets can be labelled to ensure they are routed to the correct location on site and readily identifiable.

### Fast, Easy and Flexible

Excel allows the installer or user to retain control when deciding on the product sets used within a copper or fibre optic pre-terminated system. We do not offer restricted or pre-term only product sets with inflated costs, or specific installation practices. The customer selects the product, pays the same price per component as a standard install, and Excel provides the termination and labelling service at a very competitive cost, alternatively integrators may choose to purchase products and pre-term themselves off site.

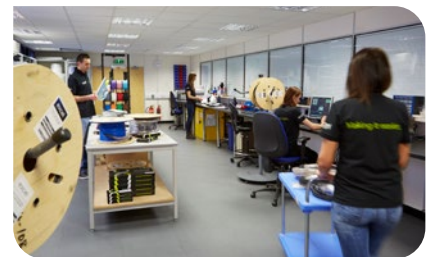

Following on from a detailed site survey of the premises, the customer will establish the lengths of cables required in each area. If it is difficult to establish exact lengths, don't worry as we have several solutions to manage overlength and allow some flexibility.

Once the products and the configuration for each area have been identified, then the cable assemblies are manufactured by Excel's skilled work force in a controlled environment. Each one is produced to the customer's specific requirements and is tested to ensure 100% reliability.

Visit the Excel website to download the Specialist Support Services brochure





# Pre-Terminated Copper Solutions



Watch Now on  
youtube



## Excel Copper Pre-terminated Solutions

Excel is able to offer pre-terminated solutions from across the entire range. This covers components from the Category 5e, 6, 6<sub>A</sub> and 7<sub>A</sub> portfolio in either unscreened or screened variants. The cables may be bundled in quantities to suit the installation using hook & loop, braised sleeving or conduit, in any quantity from 1 to 48. Also hybrid bundles can be assembled (for example: copper & fibre or coax etc.) The following are examples of product set scenarios which can be provided as pre-terminated system designs



[View our brochure](#)

### Panel to Panel or Cassette to Cassette

Main Equipment Room (MER's) and Data Centre designs call for links to be made between racks. A panel to panel style allows for installation to take place quickly and easily. Today almost all projects require deployment as fast as possible. Whilst panel-to-panel is the optimum solution, if accurate lengths are not available, Excel offers a panel to open end allowing the remote connector or panel to be terminated in the field. If lengths allow, we will make the assembly double length and double-ended to allow a full test to be carried out. Then the assembly is cut in half and supplied single-ended to the specified length. By introducing the Excel pre-terminated solution you can reduce time on site by as much 75%, ensuring the customers' network is up and running in the minimum amount of time. When pre-terminating panels, we will dress the cables according to your requirements, either to the left, right or straight. Just let us know how you need the cables presented.

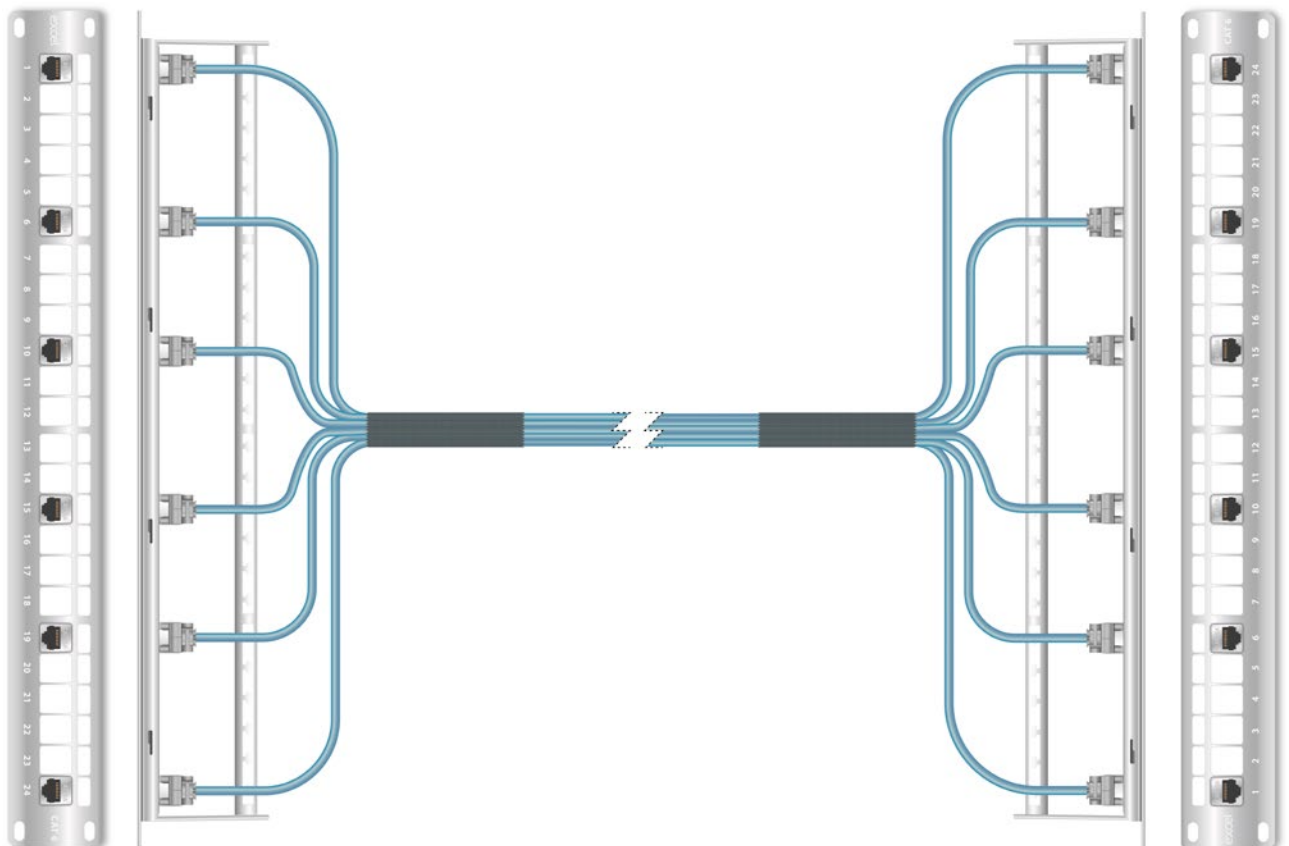

## Panel to Open

Panel to Open allows for the remote connector or panel to be terminated in the field.

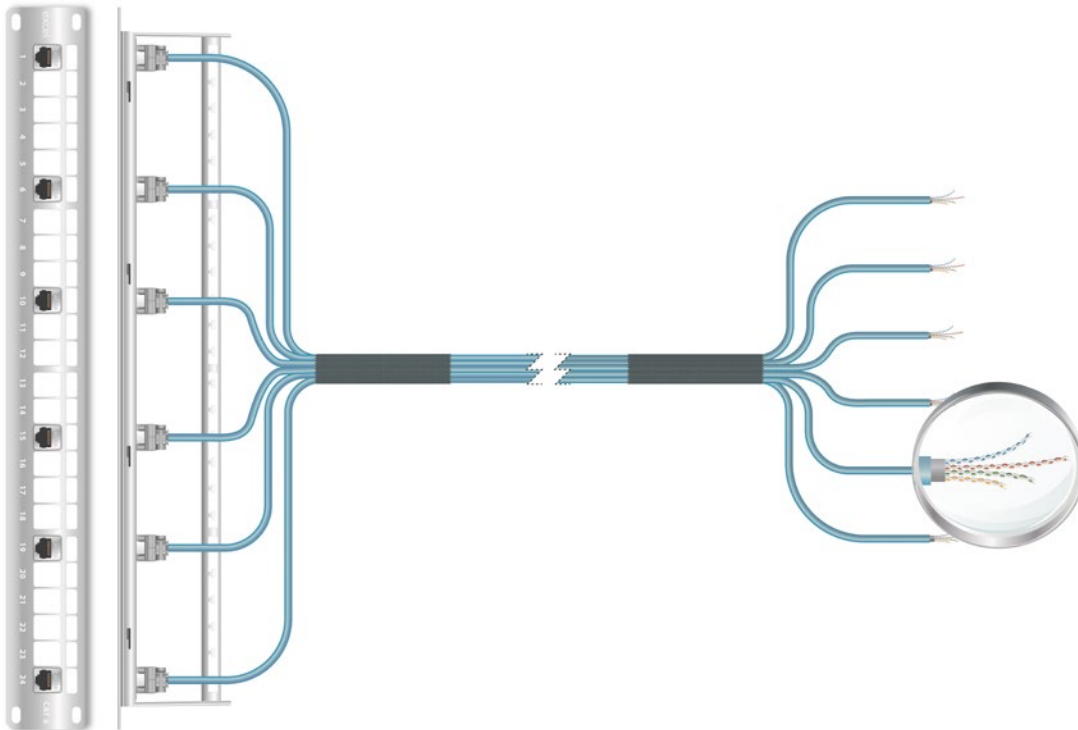

## Panel to Jack

When deploying data outlets from a patching field via horizontal distribution out to the work area in an inter-connect configuration and the site allows for accurate measurement of runs to be calculated, this can be the ideal solution to use. The remote terminated jacks can then be housed and presented in dado **trunking**, **floor boxes** or **GOP boxes** where desired with the use of Excel mounting hardware.

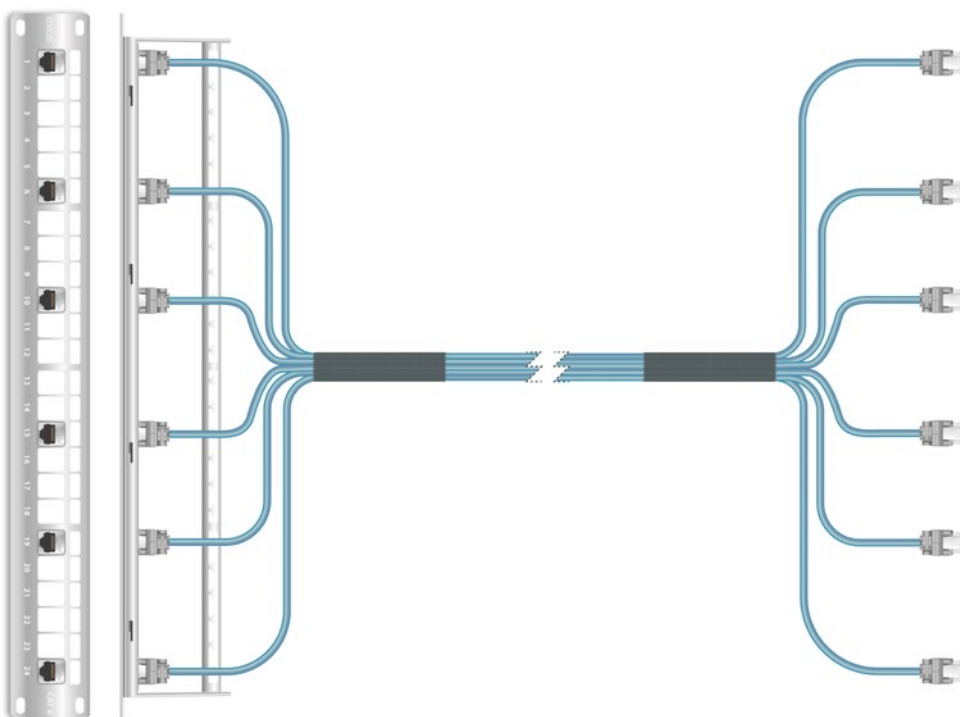

### Switch / Harness Links

The switch/harness link configuration is made up of a panel-to-plug link, the links are then dressed together to create a loom. This solution is deployed mainly in the Main Equipment Rooms allowing for a cross-connect deployment.

Solid core RJ45 to RJ45 leads can be supplied when there is the need to create switch harness links on site.

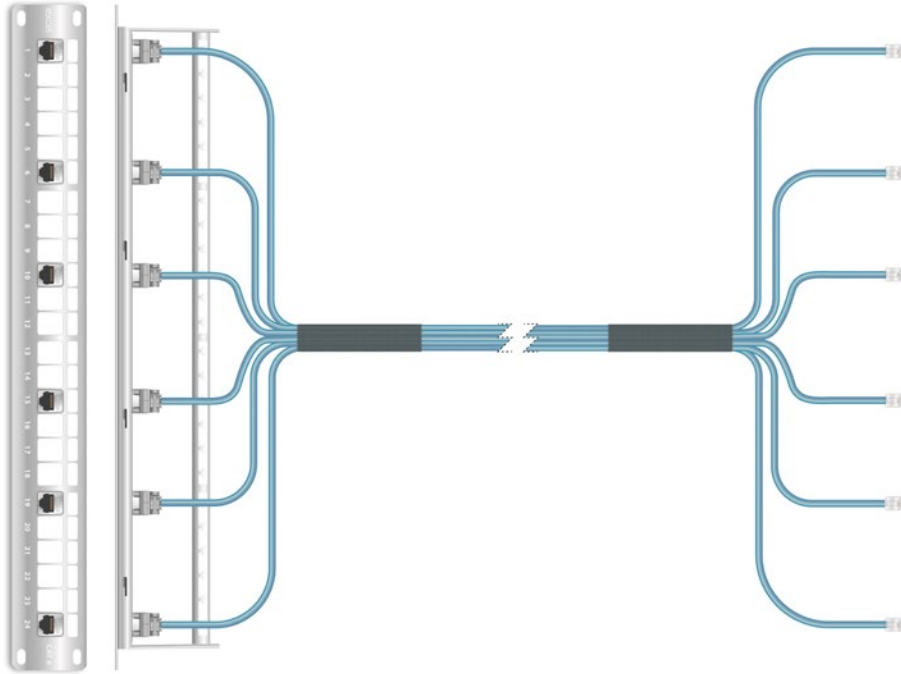

### Panel to GOP Box

With **Excel GOP boxes**, a common request received is the option to have these supplied pre-terminated. The assembly is supplied to site with the outlet jacks already terminated onto the cable and fitted within the GOP box. The flexible conduit is also in place. The patch panel jacks are installed ready for them to be inserted into the panels. And of course, all these can be pre-labelled also, further reducing time in handling time on site.

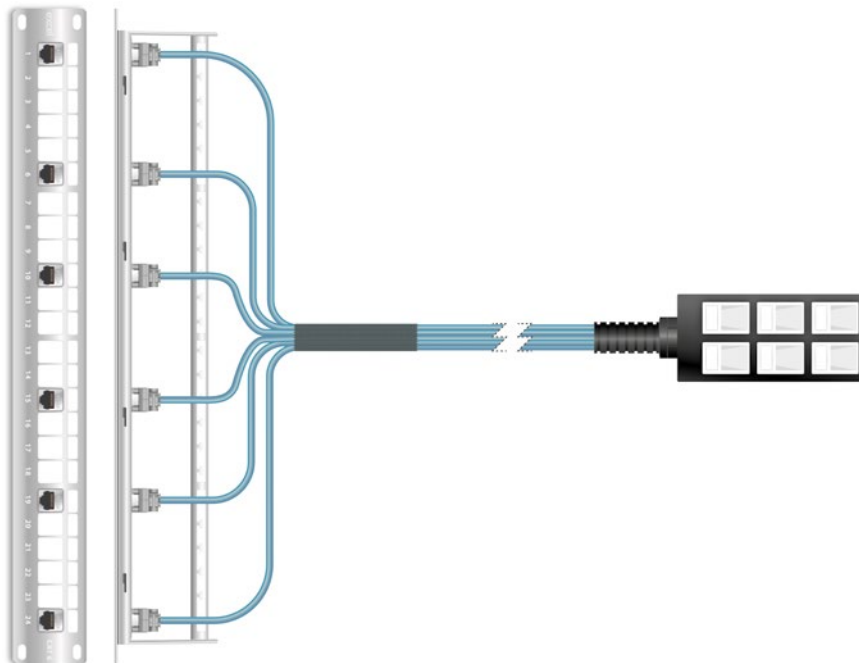



## GOP Box to Open

The **GOP box** to open configuration is a common form of pre-terminated solution and ideal for 'flood' wiring a complete floor on a grid basis allowing total flexibility for multiple re-configurations of the furniture layout. The GOP box is usually fitted to the end of a 5m length of flexible conduit that is secured to an anchor plate thereby allowing the GOP box to be moved and even brought through a grommet hole in the raised floor and secured to the desk furniture. The loom is then pulled back to the Secondary Equipment Room (SER) and terminated. This approach is an ideal solution for tight project timescales.

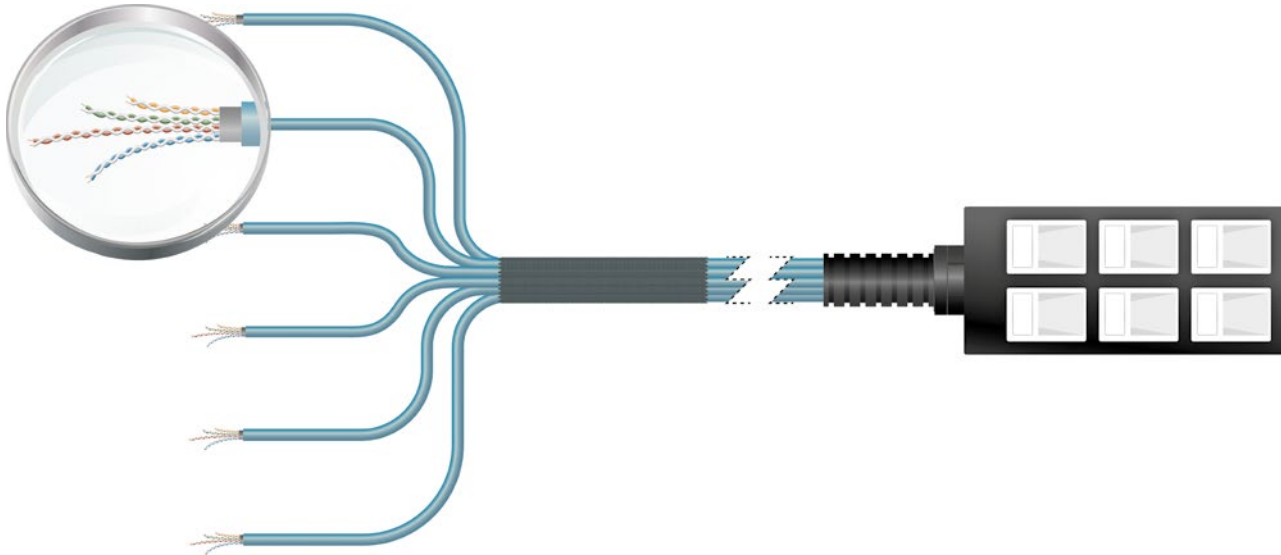

## Consolidation Point

When creating a structured cabling system that has to be flexible, due to the frequency of moves, additions and changes (MAC's) such as in schools or the health sector, the use of a consolidation point can be deployed. This solution allows for changes to take place locally to the work area without the need to access the remote data centre. The consolidation unit can also be used for staged developments within new pre-fabricated buildings. The cables can be deployed within the structure and patched together once the building is in situ.

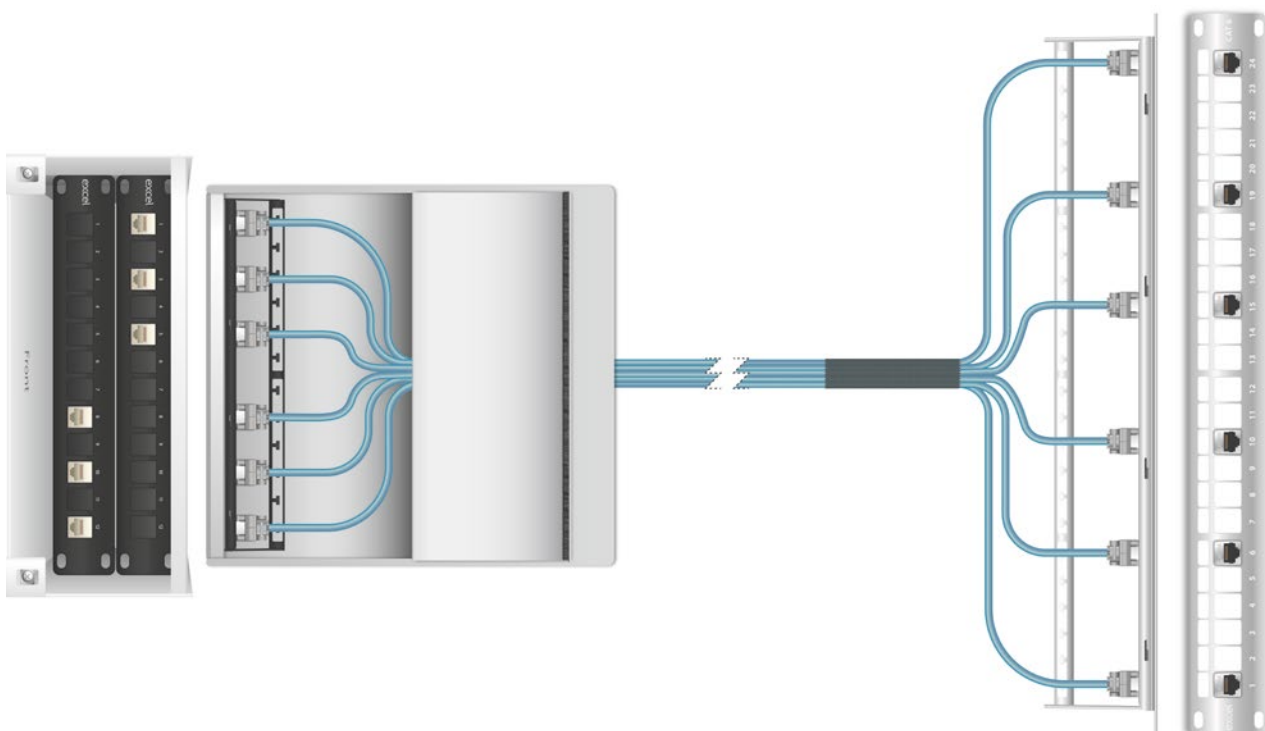

## Enquiring couldn't be simpler!

Before we can quote for a copper pre-terminated solution we require a few basic facts from you:

1. Do you require Category 7<sub>A</sub>, 6<sub>A</sub> or 6 in U/UTP, F/UTP, U/FTP, F/FTP or S/FTP?
2. What cable lengths are required?
3. Specify the number of overall terminations ie. Any number from 1 to 48 way looms, panel to panel etc
4. If fitted to a panel, are the cables to be dressed to the left or right, or straight?
5. Are there any specific labelling requirements for the cables or the panels?
6. Are the looms to be held with hook & loop ties (approx 1m apart), or braided sleeving, or fed through conduit (size dependant)?
7. Where do they need to be delivered?
8. When do you require them? Is there a schedule of priorities?

Once we have this information we will be able to provide you with a full quotation.

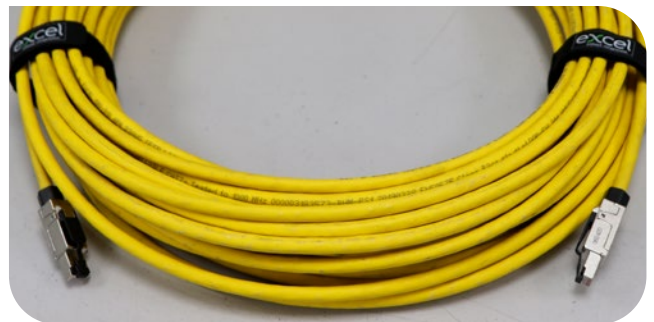
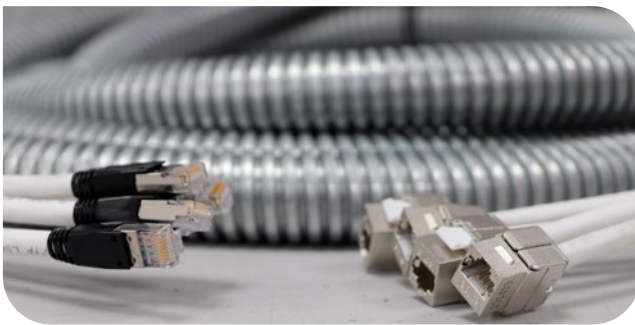

S15

Discover more about Excel's plastic free packaging in Section 2 of the Excel Encyclopaedia

**ZERO**  
Plastic Packaging

# Pre-Terminated Fibre Solutions

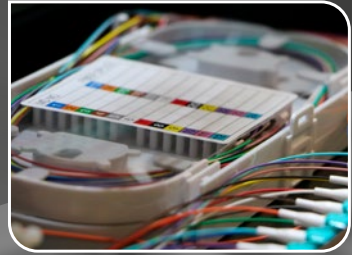
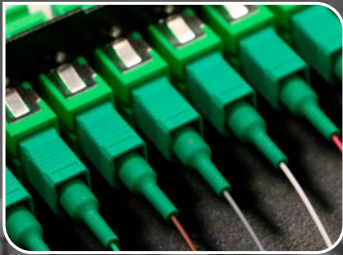

Watch Now on  
youtube





# EXCELERATOR

## Excel Excelerator Fibre Pre-terminated Solutions

The **Excelerator range** of pre-terminated fibre optic solutions have been designed for simple and quick deployment and are manufactured to the highest standards and are fully tested before being delivered to site.

Excel's Excelerator is a range of pre-terminated fibre systems including distribution, break-out and mini break-out cables and MTP solutions. You can use the Excelerator configurator to help you design the cable that you want to use, producing drawings of your solution and requesting a quotation – all within minutes..

Access the Excelerator  
<https://excel-networking.com/configurators>



## Conventional Fibre

### Distribution, Breakout, Loose Tube & Armoured Cables

Excelerator pre terminated cables are constructed from customer defined multi core 900µm micron tight buffered distribution cable or 250 micron LT, CST & SWA cable. We also offer Loose Tube unarmoured and CST and SWA armoured cables as a pre-terminated solution, all with up to 24 fibre cores. Standard options available are designed to meet most requirements and include choices of multimode and singlemode, core counts and connector styles.

Typically cables are terminated on both ends, the 'fan out' assembly will be staggered in groups of cores. Unless specified otherwise the longest fan out will measure approx. 950mm from the gland assembly to the tip of connector. The fan outs are protected by means of a transparent protection tube to which a ring style pulling eye is fixed to the remote end of the cable assembly.

Unless requested, all cable lengths are measured from tip to tip of connectors, where fan outs are staggered, this length is measured from longest fan out core to longest fan out core. Any length can be manufactured from 2.2m up to 2km.

Assemblies are generally supplied with matched connectors at ends A and B, however Excel can supply mixed connector styles for example LC to SC if required. We can also pre-terminate our range of fibre cassettes for the mixed-use panels and HD panels.

Each cable is fitted with strain relief cable glands so that they may be fitted directly to the rear of an Excel Fibre Optic Patch Panel. A generic cable identification label is affixed to each end of the assembly 50 mm from the gland, customer specific labelling schemes can be applied on request.

Excelerator Pre-Terminated cables are extremely robust, yet compact and flexible in design. This together with the range of core counts and connectivity make them ideal for use as a link from inside a patch panel to inside a patch panel, inside panel to consolidation points, or rack to rack links.



View our Brochure

## Distribution, Loose Tube, CST & SWA Cables

All cable are available from 2 core through to 24 core in OM3, OM4, OM5 and OS2, specification terminated with ST, SC or LC connectors. This makes this option ideal for backbone panel to panel and intra-building links.

Distribution cables contain buffered (900 micron) coated fibres, typically from 4 to 24 cores.

Loose Tube, CST (Corrugated Steel Tape) and SWA (Steel Wire Armoured) cables vary in construction, but all are loose tube, and gel filled. They utilise from 4 to 24 number 250 micron (primary coated) fibres within the gel-filled tube. When pre-terminated, we fit a small manifold and sleeve the primary coated fibres with 900 micron tubes (all 12 colours).

All pre-terminated cables use the TIA-598 colour coding standard.

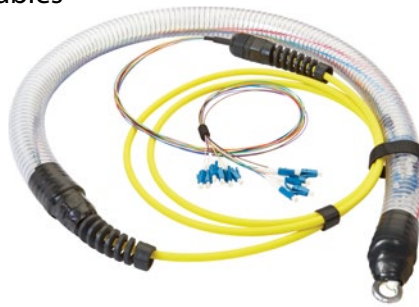

Blue
Orange
Green
Brown
Slate
White
Red
Black
Yellow
Violet
Rose
Aqua

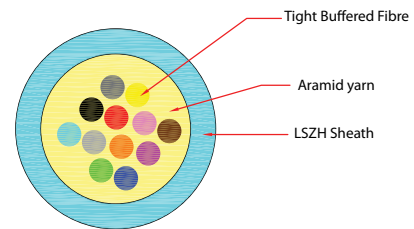
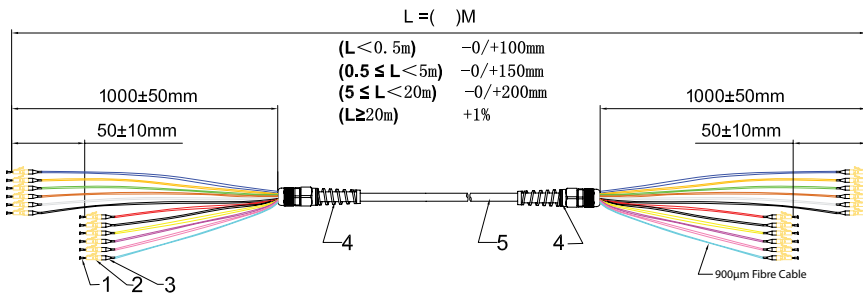

Drawing Ref	Description	Qty
1	LC (or connector as specified) Dust Cover	Core Count Specific
2	LC (or connector as specified) 0.9mm connector	Core Count Specific
3	LC (or connector as specified) 0.9mm strain relief boot	Core Count Specific
4	Gland / splitter assembly, Black	2
5	Distribution cable LSOH. Core count and Performance category customer specified	Customer specified

## Ruggedised Assemblies

Excel pre-terminated cable assemblies with ruggedised fan-outs are constructed from multi-core 900-micron, tight buffered or loose-tube 250-micron cables as required to best suit the application. Many options are available to meet most requirements and include choices of multimode and singlemode fibres, core counts and connector styles.

The assemblies can be made with 2mm/3mm ruggedised fan-outs at both ends, or as a 'hybrid' with ruggedised fan-outs on one end and 900 micron buffered fan-outs on the other end – particularly suitable as a harness link from Panel to switch.

These pre-terminated cables are supplied on plywood cable drums or coils depending on length and are fitted on both ends with a protective tube. The pulling end also has a pulling eye attached.



S15



Also available are fibre pre-terminated assemblies on re-deployable cable drums, supplied on robust steel re-deployable cable reels, which are ideal for transporting and deploying the cables into temporary applications, where they can be quickly and easily wound back onto the reel and used again and again.

Excel pre-terminated ruggedised assemblies are extremely robust yet compact and flexible in design. This, together with the range of cable options, core counts, and connectivity make them ideal for use as links from a patch panel to a switch, panel to consolidation points, or rack to rack links.

### Breakout cables

2mm ruggedised fibre contained within an outer sheath, available in increments from 2 core through to 48 core in OM3, OM4 and OS2 specification terminated with SC or LC connectors. This option is designed for direct equipment to equipment or patching connectivity.

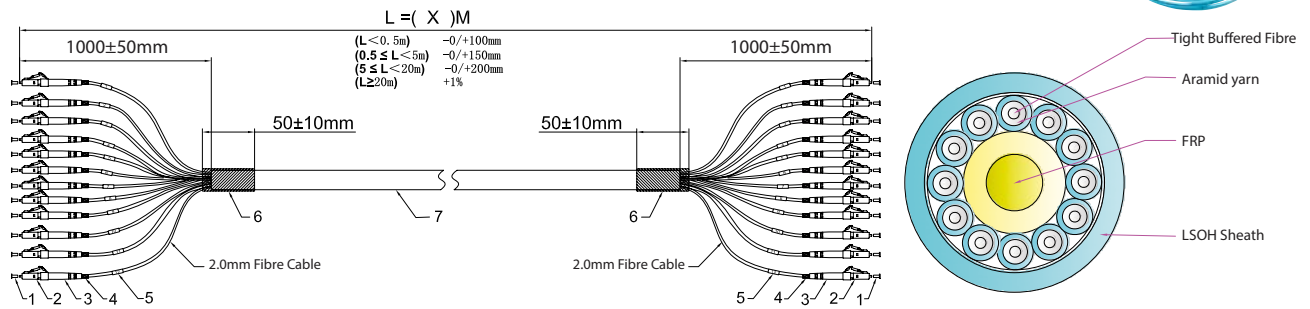

Drawing Ref	Description	Qty
1	LC (or connector as specified) Dust Cover	Core Count Specific
2	LC (or connector as specified) connector	Core Count Specific
3	LC (or connector as specified) 2mm strain relief boot	Core Count Specific
4	2.0MM Fanout Fibre Cable, 0.5Mtr as standard	Core Count Specific
5	Identification Cable	Core Count Specific
6	Heatshrink, Black	2
7	Break-out cable LSOH. Core count and Performance category customer specified	Customer specified

### Mini Breakout cables

Excelerator pre terminated Mini Break-out cables are constructed from multi core primary coated fibres within a miniature ruggedised cable.

Standard cable assemblies are designed to offer a high degree of flexibility through available features and options and include choices of multimode and singlemode, core counts and connector styles allowing each cable to be manufactured to fit the exact application.

Typically, cables are terminated on both ends with matched connectors at ends A and B, however Excel can supply mixed connector styles for example LC to SC if required.



As standard, the length of each fan out for all core counts between 8 and 48 core cables is 1 metre +/- 50mm, whether 2.0mm diameter tight buffered cable or 900 micron tubes.

The 900 micron tubes are staggered in groups of 6 or 12 cores to aid with dressing within the fibre panels with the distance between each group being 35mm. They are protected by means of a transparent protection tube to which a ring style pulling eye is fixed to one end of the cable assembly. 2.0mm fan outs are constructed to the same length.

Unless requested, all cable lengths are measured from tip to tip of connectors. Where fan outs are staggered, this length is measured from longest fan out core to the longest fan out core.

Each cable is fitted with strain relief cable glands so that they may be fitted directly to the rear of an Excel Fibre Optic Patch Panel. A generic cable identification label is affixed to each end of the assembly 50 mm from the gland; customer specific labelling schemes can be applied on request.

Excelerator Pre-Terminated Mini Break-out cables are extremely compact, lightweight and robust. This together with the range of core counts, and connectivity available make them ideal for use as link from patch panel to equipment, patch panel to patch panel, patch panel to consolidation points, or rack to rack links.

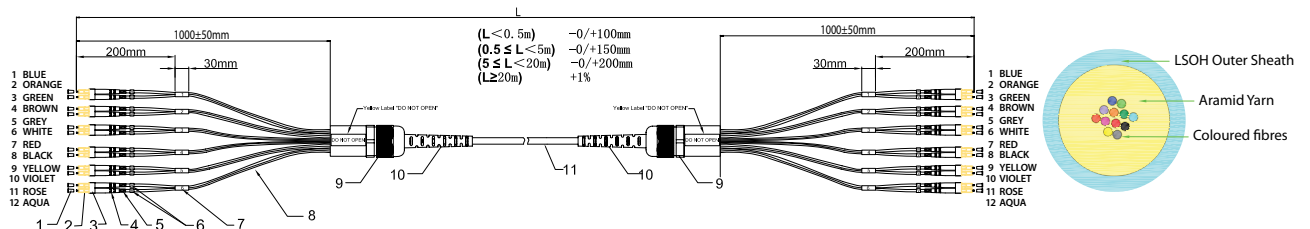



## Packaging

All of Excel's pre-terminated products are supplied in the Excel Plastic Free Packaging, more information on which can be found in **Chapter 2** of this publication.



## Enquiring couldn't be simpler!

We've developed an online Excelerator configurator that helps you to choose exactly what you need by selecting the relevant criteria.



Use our Pre-Termination Configurator Tool

Once you've chosen your requirements the configurator will provide you with a detailed drawing and a Bill of Materials (BOM) which can be emailed to our sales team to produce a quotation.

**EXCELERATOR**  
Pre-Terminated / Pre-Tested Cabling Solutions
Enquiry 0 Items

**Type**

Assembly

MTP Trunk

**Construction**

Distribution

Breakout

Mini-Breakout

**Category**

OM3

OM4

OS2

**Cores**

6

12

32

16

24

48

**Connector A**

LC

SC

**Connector B**

LC

SC

**Length (m)**

**Quantity**

[PDF](#) [+](#)

**Excel FO Breakout Assembly 32 Core OM3 LC(2mm) SC(2mm) 5m**

Product No.	Length	Quantity
209-B32-OM3-2LC-2SC-AQ-500	5m tip to tip	100pc(s)

Cable Specifications					
<b>Construction:</b>	Breakout	<b>Category:</b>	OM3	<b>Mode:</b>	Multimode
<b>Cores:</b>	32	<b>Colour:</b>	Aqua	<b>Splitter:</b>	Heat Shrink Tube

End A	End B
<b>Connector:</b> LC x 32 pcs	<b>Connector:</b> SC x 32 pcs
<b>Buffer:</b> 2mm	<b>Buffer:</b> 2mm
<b>Fanout:</b> 1000mm +/-50/50mm	<b>Fanout:</b> 1000mm +/-50/50mm

S15

# Pre-Terminated MTP Solutions

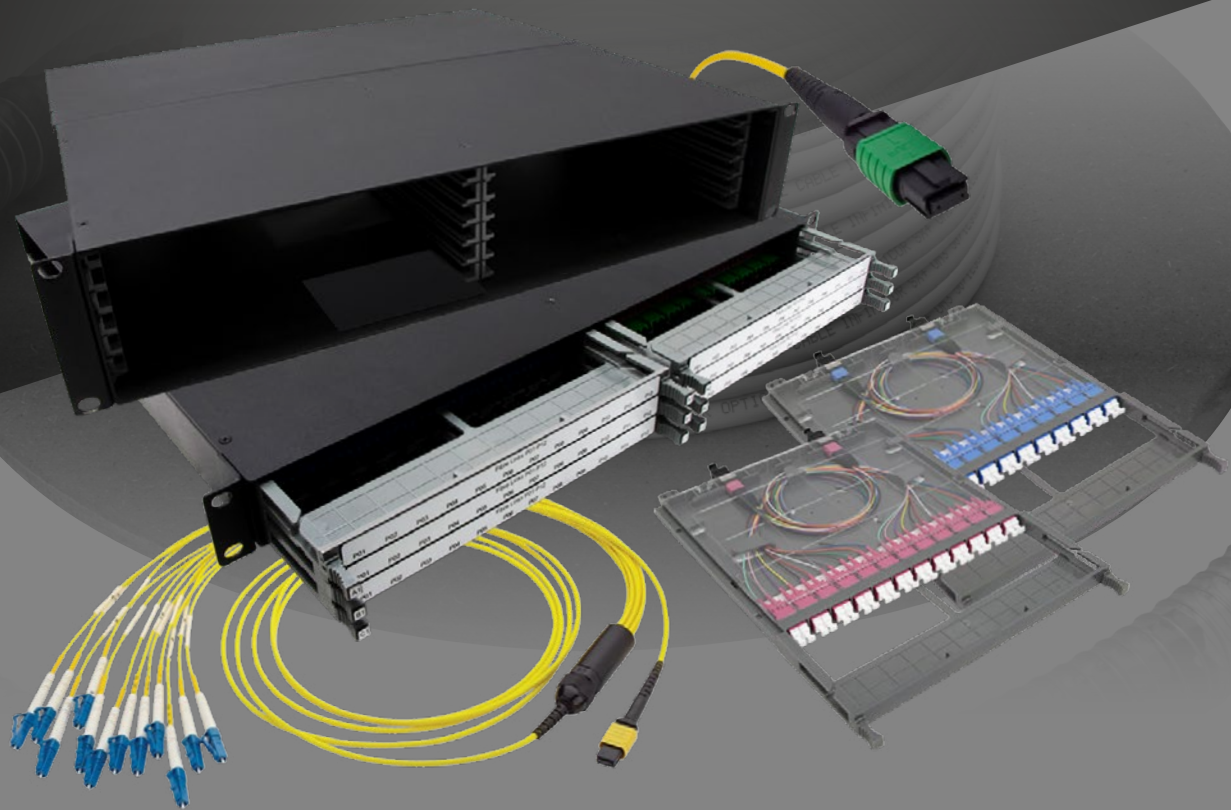

## Excelerator MTP® Solutions

The **Excel MTP fibre optic cabling system** provides a scalable, high density solution particularly suited for data centres or where space is at a premium and high availability is required. The system is suitable for OM3, OM4, OM5 and OS2 requirements, with the trunk cables offered in 8, 12, 24, 36, 48, 72, 96 or 144 configurations. They have been designed and manufactured to support both the pre-terminated and 40/100 gigabit Ethernet fibre optic installations.

Using the US Conec MTP Elite® connector the Excel MTP system ensures the superior performance with low loss properties. All Multimode MTP connectors have flat ferrules and are polished using the latest techniques to ensure that all 12 fibres protrude to ensure proper contact. All singlemode Excel MTP's are polished at an angle (APC) using the same processes to ensure fibre protrusion which guaranties correct contact of all the fibres, with the added advantage of extremely high return loss – critical in singlemode applications.

The MTP connector was introduced originally as a method of connecting 12 cores of fibre optic cable in a single connector. The original primary use was to offer a “plug and play” pre-terminated fibre optic solution.

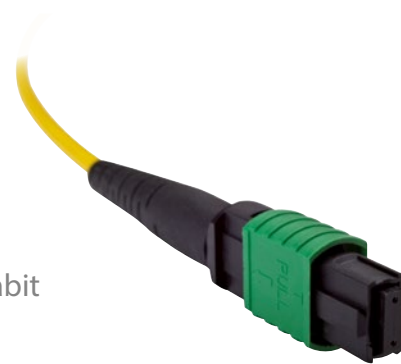

### Applications – 40GbE and 100GbE

Amongst applications that will utilise the MTP connector. These are:

40GBASE SR4 – 40 Gigabit Ethernet

100GBASE SR10 – 100 Gigabit Ethernet

100GBASE SR4 – 100 Gigabit Ethernet

These applications will use multimode optical fibre, specifically OM4 category.

The Ethernet speeds described above will be obtained using parallel optical transmission. Parallel optics is based on multiple transmissions of 10 Gigabit Ethernet over fibre. This means that to support 40 Gigabit Ethernet, four transmit fibres and four receive fibres will be required. This will be achieved using the outermost 8 cores of the MTP with the central 4 left unused.

100 Gigabit Ethernet (SR10) will use ten cores to transmit and ten to receive. This in turn will require 2 MTP links, each having 10 cores of the fibre being utilised. As 100 Gigabit Ethernet will use two MTP channels the connectors can be either stacked vertically or horizontally. The newer 100 Gigabit Ethernet (SR4) application will use four (Tx) and four (Rx) cores, permitting one MTP connector to support one channel.





## The Excel Excelerator MTP Range

The **Excelerator MTP®** portfolio has been configured to ensure that it will work with both 2 core channels and array cables.

The MTP Elite® connector is manufactured with or without pins. The connection must be between one of each to ensure correct alignment of the fibre therefore the trunk cables will be provided with pins, any future MTP® patch leads (used to connect the equipment to the patch panel) will be provided without pins. The Excel MTP® portfolio follows the connecting method detailed in EN 50174-1:2009+A1:2011, TIA 568-C-3 method B and ISO14763-3. We can however, accommodate all polarity methods on request.

The **Excelerator MTP®** portfolio can work with both 2 core (duplex) channels and parallel array channels.

### Excelerator MTP® Trunk Cables

8, 12, 24, 36, 48, 72, 96 and 144 core assemblies are available. This corresponds to 1, 2, 3, 4, 5, 6, 8 or 12 MTP® connectors at each end contained within an additional outer sheath: Trunk cables are always pinned.

This length is always measured tip to tip so it is recommended to round up to the nearest metre in length and do not forget any vertical drops and "Service loops". Correctly managed service loops do not affect the performance of the fibre.

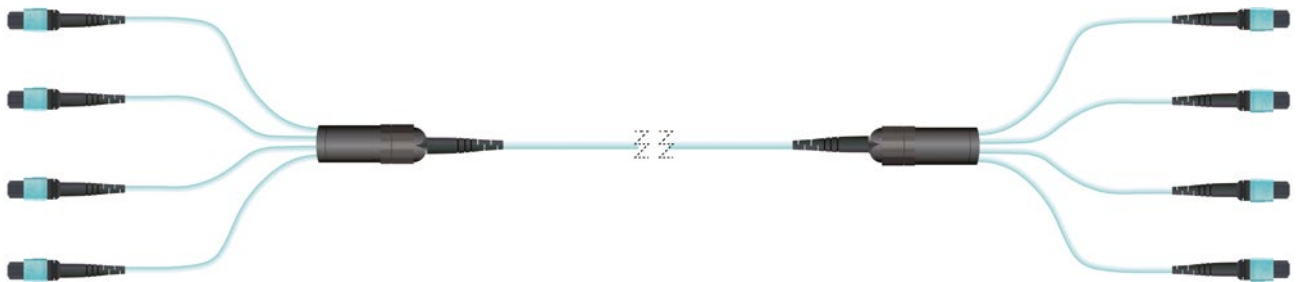
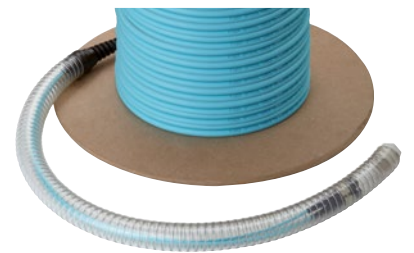

### Excelerator MTP® Cassettes

The MTP cassettes come in either 12 or 24 core LC and OM3, OM4, OM5 and OS2(APC) variations. The different Polarity method such as Method A and Method C is achieved with alternate cassettes at each end. However you don't need to worry about how this is achieved. By answering some simple questions the Excel Sales Team can propose the correct solution for your needs.

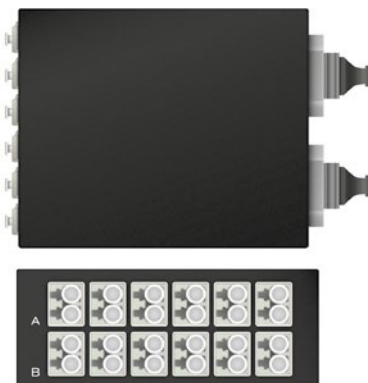
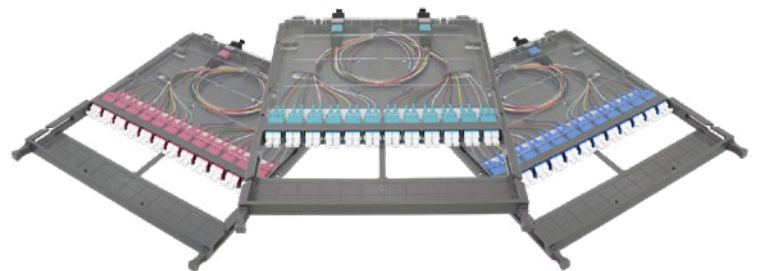

### Excelerator MTP® Patch Panel Frames

There are four options for mounting cassettes. We have a range of platforms to suit requirements. These include the traditional metal cassettes and associated panels, the ExpressNet panel & cassette system, which can house a variety of cassette-based products, both copper and fibre, and the High density range which can accommodate up to 144 LC/MTP connections or 48 MTP through connections (576 fibres) in 1U of space.

The angled frame can accept 4 and the straight panel accepts up to 5 of the metal MTP-LC cassettes. These cassettes are available with either one or two MTP's (12 or 24 fibre). When populated with the 24 core LC cassette provides density of 120 fibre cores in 1U.



The ExpressNet platform can accept up to 8 cassettes.

The patch panel frames are sold unloaded. Any empty cassettes can be populated at a later date without disturbing existing services. The patch panels also allow a mix of fibre optic grades to be presented within the same patch panel.



Watch our Video

The HD (High Density) platform consists of a 1U panel which can house up to 12 cassettes. These cassettes each contain one MTP to 12 LC fan out arrays inside. The panel provides up to 144 fibres in 1U of rack space.



All patch panel frames are sold unloaded. Any empty cassettes can be populated at a later date without disturbing existing services. The patch panels also allow a mix of fibre optic grades to be presented within the same patch panel.

### Excelerator MTP® Through Couplers

There are a number of options for mounting through couplers for use with the MTP-LC Fanouts depending on the platform selected. There are 2 versions of the through couplers:

Multimode couplers are aligned key couplers, whilst singlemode couplers are opposite key couplers (otherwise known as Key up/key down couplers).

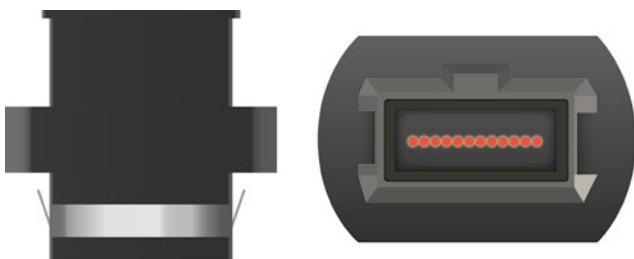

### Excelerator MTP® Patch Leads

The MTP patch Leads are used for direct connection of equipment. They are available in both standard and custom lengths. Patch Leads are always unpinned.

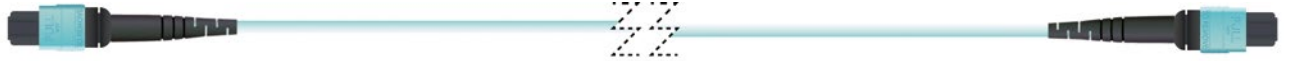

### Excelerator MTP® – LC Fanout

These are used to connect from a through coupler panel directly into LC switch ports. They are available in OM3, OM4, OM5 and OS2 (APC) variations and come complete with clips to convert the simplex LC fanout leads into duplex. The benefit of this approach is that it reduces the losses in the channel by one mated connection.

They are available in both standard and custom lengths, however the actual length of the fanout is always 500mm.

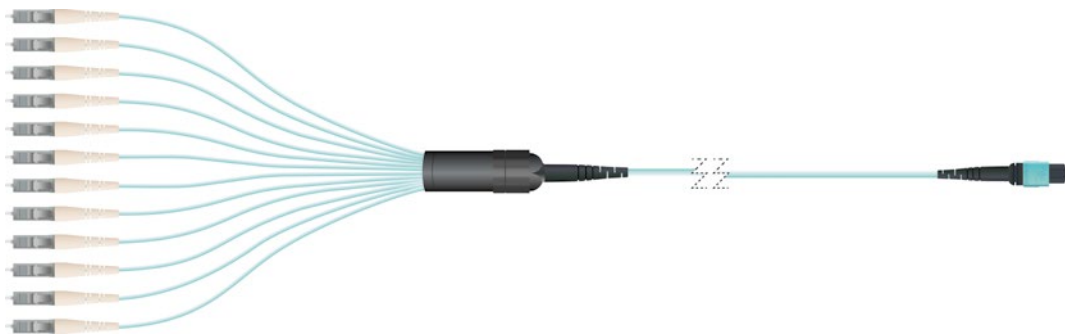
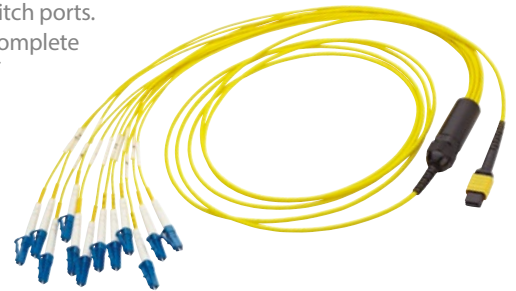

### MTP Polarity Methods

If you are unsure; if you put light in Core 1 where do you expect the light to come out?

Answer:

Method A = Core 1. Method B = Core 12. Method C = Core 2

NB. You need a cassette at both ends to achieve the desired polarity output.

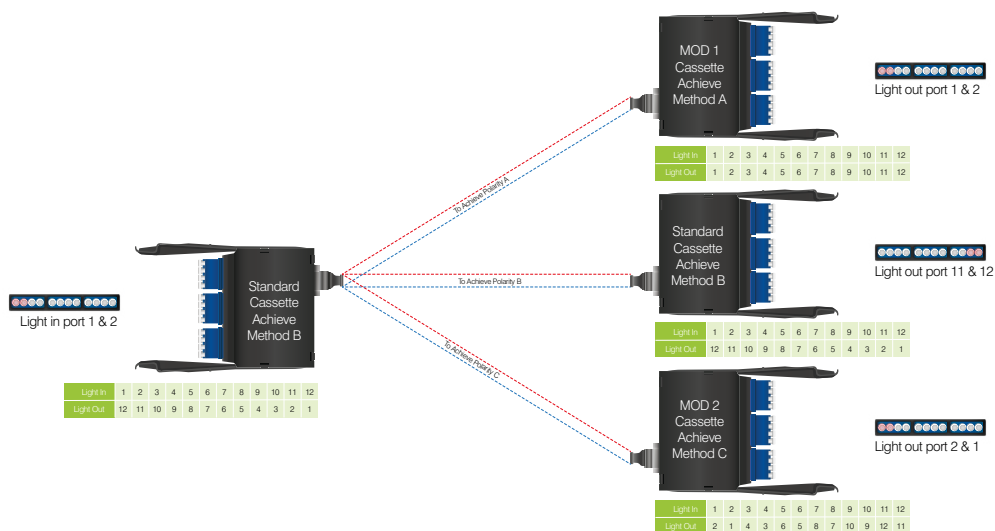

# Bespoke Laser Engraved Labelling



Watch Now on  
youtube





Excel's comprehensive range of labelling solutions ensures that every application is professionally labelled from the moment it is installed.

Excel offers a variety of labelling services to suit any requirement. Whether you are installing cabinets, patch panels, GOPs, outlets or cable, labelling is a crucial stage of the project to ensure the finished product is as efficient as possible for the end user. With specialised laser engraved technology, Excel has the capacity to offer a bespoke, "made-to-measure" service, even down to whether the labels are pre-affixed to your equipment or sent as standalone label sheets.

Using laser-engraved technology and specially developed materials, Excel offers a cost-effective solution to your labelling needs. Our range of templates is continuously evolving, so we can offer an infinite array of labels in a number of colours to suit any cabling solution. The labels are printed in a sheet format, and with the provision of customer specification, we can provide them as individually printed adhesive sheets or already attached to the equipment ordered. The laser cuts in a direct straight line meaning there is no border around each label. For smaller label sizes, this means we can make the most of every millimetre of printing space. We are able to cut any shape of label required, although primarily our service will revolve around networking infrastructure. With that said, thanks to the accuracy and precision of the laser printing technology, we are able to engrave company logos onto the labels for enhanced aesthetics, making the installation individual to the customer. We can also engrave directly onto plastic components such as faceplates, modules and shutters.

#### How does it work?

The label sheets are made using a plastic base sheet covered with a micro-thin layer of ink which is protected by a specialised coating. The laser essentially vaporises the top colour coating to reveal the colour of the base sheet, which ultimately explains the colour of the label text. The rear is then coated in a high-performance 3M adhesive, which has been tested to operate within a temperature range of minus 30 to over 70 degrees Celsius.



#### Features

- 2-colour laminate sheets
- Acrylic composition
- Strong adhesive backing
- Range of colours, shapes & sizes
- UV resistant
- Laser engraved
- High quality
- Same day despatch

#### Technical Specifications

- Material - Acrylic
- Thickness 0.9mm nominal
- Adhesive back - 3M 467MP
- Maximum sheet size: 300mm x 450mm
- Temperature range: -30C to +70C
- Fire classification UL94 HB
- Electrical insulator
- RoHS compliant

S15



Visit the Excel website to download the labelling brochure



## Availability

L-FP-10-XX/XX	Full panel (24-way) up to 450 x 10mm high
L-FP-15-XX/XX	Full panel (24-way) up to 450 x 15mm
L-FP-44-XX/XX	Full panel mask label - up to 450 x 44mm
L-HP-10-XX/XX	Half panel (12-way) up to 225 x 10mm high
L-HP-15-XX/XX	Half panel (12-way) up to 225 x 15mm high
L-HP-44-XX/XX	Half panel mask label - up to 225 x 44mm
L-OT-XX/XX	Outlet label (up to 25mm x 15mm)
L-RK-S-XX/XX	Rack label - Small (up to 20mm x 50mm)
L-RK-M-XX/XX	Rack label - Medium (up to 30mm x 80mm)
L-RK-L-XX/XX	Rack label - Large (up to 50mm x 100mm)
L-RK-XL-XX/XX	Rack label - Extra Large (up to 75mm x 100mm)
L-LM-S-XX/XX	Loom Label (with 4 holes) - Small (up to 10mm x 50mm)
L-LM-M-XX/XX	Loom Label (with 4 holes) - Medium (up to 15mm x 80mm)
L-LM-L-XX/XX	Loom label (with 4 holes) - Large (up to 20mm x 100mm)
L-LM-XL-XX/XX	Loom label (with 4 holes) - Extra large (up to 30mm x 150mm)

WHITE WT/BK	ORANGE OR/WT
BLACK BK/WT	ORANGE OR/BK
SILVER SR/BK	VOILET VT/WT
BLUE BL/WT	GREEN GN/WT
RED RD/WT	YELLOW YW/BK

XXXX denotes colour

Note for Loom Labels we have 3 colours:

YELLOW/BLACK (YW/BK)

RED/WHITE (RD/WT)

WHITE/BLACK (WT/BK)

Loom labels are thicker material (1.6mm) and Non-Adhesive with 4 holes for cable ties to tie to the looms.



### How to Order?

- Place your order as normal with your local sales team.
- In a spreadsheet format, provide your sales rep with:
  - The part number(s) for the item(s) to be labelled (if Excel products) or exact dimension details of third party items
  - Label size and colours required, including full/half panel and specific height requirements – according to Excel Networking part codes (see above and insert the colour code as required)
  - Quantity of labels required
- Details of specific printing required, in accordance with job specifications
- We will pass this information to our labelling specialists who will produce your labels to either be shipped as label sheets, or to be affixed to other items in your order prior to it being delivered.

S15



## Why Choose Labelling from Excel?



### Service & Support

Our dedicated sales and technical support teams are on hand to help with the production of labels to ensure the results are accurate first time, every time.

As part of our engraved labelling value added service, all labels commence printing in-house on the day we receive the specification, with a view to despatching them on the same day\* for next day delivery within the UK. Our dedicated sales and technical support teams are on hand to help with the completion of any spreadsheets or technical information, to offer a hassle-free, quick and efficient process.

*\*If purchased before 2pm.*

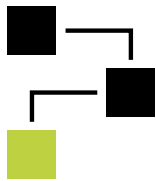

### Flexibility

With a range of colours, sizes and materials as well as the ability to customize the label text, the service is flexible to suit the needs of all customers. Whether you choose the Sharpmark solution or Excel's laser engraved labelling, the range of options is plentiful to ensure you achieve the labelling solution you and your end-user require.

The added benefit of choosing Excel's engraved labelling service is that it is offered either as standalone printed and cut label sheets for application after equipment installation, or pre-affixed to the equipment according to the specification provided, meaning you don't even have to think about labelling whilst on-site. There is also a vast array of colour options available, even beyond the standard eight - for details about alternative colour availability, please contact the sales team.



### Time Saving

By eliminating the need to think about labelling during installation, or fiddle around with a pen and narrow slips of paper on-site, the labelling solutions we offer are proven to save a considerable amount of project time, reducing overall cost.



### Long-Term Quality & Reliability

Sharpmark Software is convenient and cost effective, there is no need for custom printers to produce professional-looking labels that are durable and easy to read. Combined with high quality printable labels from Sharpmark, the software allows you to organise and label installations clearly, minimising downtime for regular maintenance or trouble-shooting.

To ensure the highest quality, long-term durability and top performance, Excel's engraved labelling solution uses the best quality materials on the market. The acrylic material is fadeproof, retaining its bold colour for many years after engraving and installation. The laser technology eliminates the risk of diminishing ink visibility, by cutting through the top acrylic layer to reveal crystal clear text in the chosen colour.



### Bespoke Service

Our labelling solutions 100% bespoke services, printed to the needs of the individual. This 'made-to-measure' nature means that you are able to choose anything to appear on your labels to meet the requirements of the end-user; specific destination locations, particular equipment, company logos - the options are endless.

Please contact the sales team for more information about the capabilities of our service –

[sales@excel-networking.com](mailto:sales@excel-networking.com), or 0121 326 7557.





# Pre-Configured Racks and On-Site Rack Assembly



Watch Now on  
youtube





Our pre-configured racks and on-site assembly services cover the complete range of Excel Environ floor and wall racks.

As part of this specialised service, we can install the majority of kit that you need and deliver it ready configured to site, or indeed configure it in-situ. This service helps you to reduce installation costs and times, equipment, packaging and specialist labour costs and is covered by the 25-year Excel system warranty when installed by an accredited partner.

Our team operate with a fast turnaround, typically two working days.

### Features

We pre-install items, exactly where required including:

- PDUs - horizontal & vertical
- Fan trays + Patchcord/cable management
- Shelves - all types Cable tray/basket
- Pre-loomed cabling - patchcords, power etc.
- Environ Electronic Lock Solutions
- Special locks - unique keys, combination locks, RFID locks
- Pre-approved layout drawing/specification
- Pre-labelled

### Pre-Configured Racks

Our team of experienced cabinet builders will build the Environ rack(s) to the pre-determined specification, inclusive of shelving, fan trays, PDUs, Environ locks and any cable management. The rack(s) will be configured in our dedicated Environ warehouse facility in Birmingham by a team of experts. They will then be delivered to site through a courier service, ready for you to position in the appropriate location.

### On-Site Rack Assembly

The Environ racks (flat packed), together with any additional accessories that you've ordered, including shelves, cable management, PDUs etc. would be delivered to site by our normal delivery service the day before the planned installation. Our experienced team of cabinet builders will visit the location, position the rack(s) and build them to the agreed specification. position in the appropriate location.



Visit the Excel website to download the Pre-Configured Rack brochure

